

# Proportional pressure relief valve, direct operated, decreasing characteristic curve

**RE 18139-05/07.12** 1/14  
Replaces: 11.11

**Type KBPS.8B** (High Performance)

Component size 8  
Component series A  
Maximum operating pressure 420 bar  
Maximum flow 2 l/min



H7071

## Table of contents

Contents	Page
Features	1
Ordering code	2
Preferred types	2
Function, section, symbol	3
Technical data	4, 5
Characteristic curves	6 to 9
Minimum terminal voltage at the coil and relative duty cycle	10, 11
Unit dimensions	12
Mounting cavity	13
Available individual components	14

## Features

- Cartridge valve
  - Mounting cavity R/T-8A
  - Direct operated proportional valve for limiting a system pressure
  - Suitable for mobile and industrial applications
  - Operation by means of proportional solenoid with central thread and detachable coil
  - Fine adjustment of the command value pressure characteristic curve possible from the outside at the control electronics
  - Set to the maximum pressure via the adjustment screw
  - In case of power failure, maximum set pressure
- | Control electronics:                                 | Data sheet |
|--|------------|
| • Plug-in proportional amplifier<br>type VT-SSPA1... | 30116      |
| • Analog amplifier type RA...                        | 95230      |
| • BODAS control unit type RC...                      | 95200      |

Information on available spare parts:  
[www.boschrexroth.com/spc](http://www.boschrexroth.com/spc)

## Ordering code

KBPS		8	B	A / H	C			V	*
Proportional pressure relief valve, direct operated (pilot control valve)									Further details in the plain text
<b>Pressure rating</b>									<b>no code =</b> Standard
up to 30 bar			= B						-8 = Coil 800 mA (see page 5)
up to 50 bar			= C						<b>Seal material</b>
up to 100 bar			= F						V = FKM seals
up to 150 bar			= H						Attention!
up to 210 bar			= L						Observe compatibility of the seals with the hydraulic fluid used!
up to 250 bar			= N						<b>Electrical connection</b> <sup>1)</sup>
up to 315 bar			= P						<b>K4 =</b> Without mating connector, with connector according to DIN EN 175301-803
up to 350 bar			= R						<b>K40 =</b> Without mating connector, with connector DT 04-2PA (Deutsch plug)
up to 420 bar			= T						<b>C4 =</b> Without mating connector, with connector AMP Junior-Timer
Component size 8		= 8							<b>Supply voltage</b>
Maximum pressure with command value = 0			= B						<b>G12 =</b> Control electronics 12 V DC
Component series				= A					<b>G24 =</b> Control electronics 24 V DC
High Performance and mounting cavity R/T-8A (see page 13)					= H				
Proportional solenoid, wet-pin						= C			

<sup>1)</sup> Mating connectors, separate order, see data sheet 08006.

## Preferred types

Type	Material number
KBPSB8BA/HCG24C4V-8	R901144800
KBPSL8BA/HCG24C4V-8	R901120007
KBPSR8BA/HCG24C4V	R901018607
KBPSL8BA/HCG12C4V	R901056361
KBPSL8BA/HCG24C4V	R901018602
KBPSL8BA/HCG12K40V	R901064385
KBPSN8BA/HCG24K40V	R901016229
KBPSP8BA/HCG24K40V	R901026207
KBPSR8BA/HCG24K40V	R901188705
KBPSP8BA/HCG24K4V	R901018593

## Function, section, symbol

### General

Valves of type KBPS.8B are direct operated proportional pressure relief valves (pilot control valves) in seat design and are used to limit a system pressure. They basically comprise of the pole tube (3), the solenoid coil (4), the valve seat (5) and the valve poppet (6).

With command value 0 or in case of power failure, the maximum pressure is set. Operation by means of a proportional solenoid with central thread and detachable coil. The solenoid's interior is connected to the main port ② and filled with hydraulic fluid. Depending on the electric command value, these valves can be used to continuously set the system pressure to be limited.

### Basic principle

In the factory, the valves are mechanically set to the maximum pressure. For the proportional reduction of the system pressure, a command value is specified at the control electronics. Depending on the command value, the electronics actuate the solenoid with electric current.

The proportional solenoid converts the electric current into mechanical force that acts against the setting spring via the armature and thus reduces the force on the valve poppet (6). The valve poppet (6) pushes onto the valve seat (5) and blocks the connection between main port ① and ②. If the hydraulic force on the valve poppet (6) corresponds to the force difference between setting spring and solenoid force, the valve controls the set pressure by lifting the valve poppet (6) off the valve seat (5) and thus enabling hydraulic fluid flow from main port ① to ②. If the command value is zero, the maximum pressure is set.

### Notice!

Occurring tank pressures (main port ②) are added up to the set values in the main port ①.

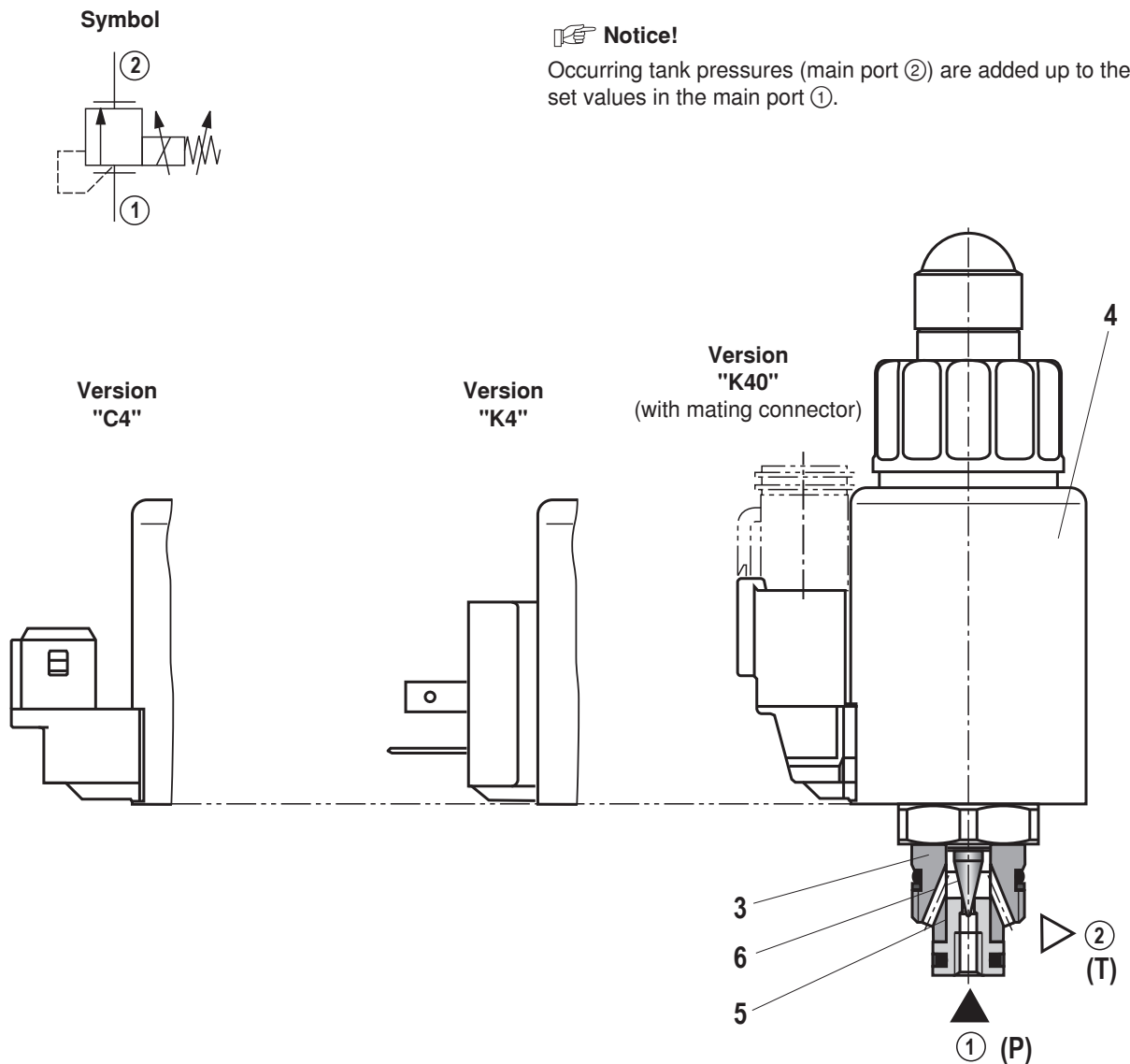

**Technical data** (For applications outside these parameters, please consult us!)

<b>general</b>		
Weight	kg	0.45
Installation position		Any - if it is ensured that no air can collect upstream the valve. Otherwise, we recommend suspended installation of the valve.
Ambient temperature range	°C	-20 to +120
Storage temperature range	°C	-20 to +80

**Environmental audits:**

<b>Vibration test according to DIN EN 60068-2 / IEC 60068-2 / 2 axes (X/Z)</b>		
DIN EN 60068-2-6: 05/96	Vibrations, sine-shaped	10 cycles (5 Hz to 2000 Hz back to 5 Hz) with logarithmic frequency changing speed of 1 octave/min, 5 to 57 Hz, amplitude 1.5 mm (p-p), 57 to 2000 Hz, amplitude 10 g
IEC 60068-2-64: 05/93	Vibrations (random) and broadband noise	20 to 2000 Hz, amplitude 0.05 g <sup>2</sup> /Hz (10 g RMS/30 g peak), testing time 30 min
DIN EN 60068-2-27: 03/95	Shocking	Half sine 15 g / 11 ms, 3 x in positive, 3 x in negative direction (a total of 6 individual shocks)
DIN EN 60068-2-29: 03/95	Bump test	Half sine 25 g / 6 ms, 1000 x in positive, 1000 x in negative direction (a total of 2000 individual shocks)

Indication per axis

<b>Climatic test according to EN 60068-2 / IEC 60068-2 (environmental test):</b>		
DIN EN 60068-2-1: 03/95	Storage temperature	-40 °C, duration 16 h
DIN EN 60068-2-2: 08/94		+110 °C, duration 16 h
DIN EN 60068-2-1: 03/95	Cold test	2 cycles -25 °C, duration 2 h
DIN EN 60068-2-2: 08/94	Dry heating test	2 cycles +120 °C, duration 2 h
IEC 60068-2-30: 1985	Humid heat, cyclic	Variant 2/ +25 °C to +55 °C 93 % to 97 % relative humidity, 2 cycles à 24 h

**Salt spray test: 720 h according to DIN 50021**

→ Coating generally not necessary. If paint is applied nevertheless, the reduced heat dissipation capacity is to be observed.

**hydraulic**

Maximum operating pressure <sup>1)</sup> (main port ①)	bar	420
Maximum admissible return flow pressure (main port ②)	bar	210
Maximum set pressure <sup>2)</sup>		See command value pressure characteristic curves page 6
Minimum set pressure with command value max <sup>3)</sup>		See characteristic curves page 8 and 9
Maximum flow	l/min	2 (see characteristic curves page 6 and 7)
Hydraulic fluid		See page 5
Hydraulic fluid temperature range	°C	-20 to +80
Viscosity range	mm <sup>2</sup> /s	15 to 380
Maximum permitted degree of contamination of the hydraulic fluid - cleanliness class according to ISO 4406 (c)		Class 20/18/15 <sup>4)</sup>

<sup>1)</sup> **Attention!** The maximum operating pressure is the total of set pressure and return flow pressure!<sup>2)</sup> **Attention!** The valves are set in the factory. In case of subsequent adjustment, the warranty will become invalid!<sup>3)</sup> If the valve is installed in a mounting cavity made of non-magnetically conductive material, the minimum set pressure is slightly higher.<sup>4)</sup> The cleanliness classes specified for the components must be adhered to in hydraulic systems. Effective filtration prevents faults and at the same time increases the service life of the components.For the selection of the filters see [www.boschrexroth.com/filter](http://www.boschrexroth.com/filter).

## Technical data (For applications outside these parameters, please consult us!)

### hydraulic

Hysteresis <sup>5)</sup>		< 4 % of the max. set pressure
Range of inversion <sup>5)</sup>		< 0.5 % of the max. set pressure
Response sensitivity <sup>5)</sup>		< 0.5 % of the max. set pressure
Manufacturing tolerance of the command value pressure characteristic curve	– Command value 100 %	< 2 % of the max. set pressure
	– Command value 0	< 5 % of the max. set pressure
Step response ( $T_u + T_d$ ) 0 → 100 % and/or 100 % → 0	ms	70 (depending on the system)

Hydraulic fluid	Classification	Suitable sealing materials	Standards
Mineral oils	HL, HLP	FKM	DIN 51524
Bio-degradable	– Insoluble in water	HEES	VDMA 24568
	– Soluble in water	HEPG	
 <b>Important information on hydraulic fluids!</b> ▶ For more information and data on the use of other hydraulic fluids refer to data sheet 90220 or contact us! ▶ There may be limitations regarding the technical valve data (temperature, pressure range, service life, maintenance intervals, etc.)!		▶ The flash point of the hydraulic fluids used must be 40 K higher than the maximum solenoid surface temperature. ▶ <b>Bio-degradable:</b> When using bio-degradable hydraulic fluids that are simultaneously zinc-solvent, zinc may accumulate in the fluid.	

### electric

Supply voltage	V	12 DC	24 DC	"-8" / 24 DC	
Maximum control current	mA	1760	1200	800	
Coil resistance	– Cold value at 20 °C	Ω	2.3	4.8	11.5
	– max. hot value	Ω	3.8	7.9	18.9
Switch-on duration	%	100 <sup>6)</sup>			
Maximum coil temperature <sup>7)</sup>	°C	150			
Protection class according to DIN EN 60529	– Version "K4"	IP 65 with mating connector mounted and locked			
	– Version "K40"	IP 69K with mating connector mounted and locked			
	– Version "C4"	IP 66 with mating connector mounted and locked IP 69K with Rexroth mating connector (material no. R901022127)			
Control electronics (separate order)		– Plug-in proportional amplifier type VT-SSPA1..., see data sheet 30116 – Analog amplifier type RA..., see data sheet 95230 – BODAS control unit type RC..., see data sheet 95200			
Design according to VDE 0580					

<sup>5)</sup> Measured with analog amplifier type RA1-1/10, see data sheet 95230

<sup>6)</sup> In case of use more than 2000 m a.s.l., please consult us.

<sup>7)</sup> Due to the surface temperatures of the solenoid coils, the standards ISO 13732-1 and EN 982 need to be adhered to!

**In the electrical connection, the protective earthing conductor (PE  $\perp$ ) must be connected properly.**

**Characteristic curves** (measured with HLP46,  $\vartheta_{oil} = 40 \text{ }^\circ\text{C} \pm 5 \text{ }^\circ\text{C}$  and 24 V coil)

**Pressure in main port ① depending on the command value. Flow = 0.8 l/min**

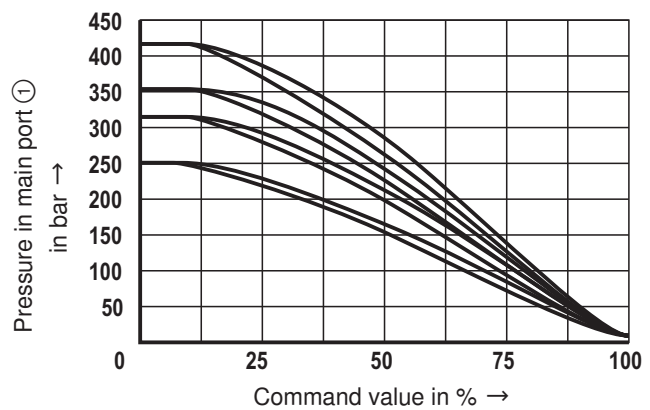
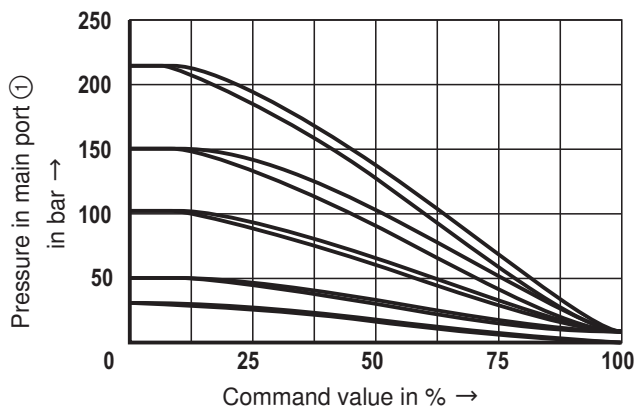

**Pressure in main port ① depending on the flow.**

(The characteristic curve was measure without counter pressure in main port ②.)

**Pressure rating 30 bar**

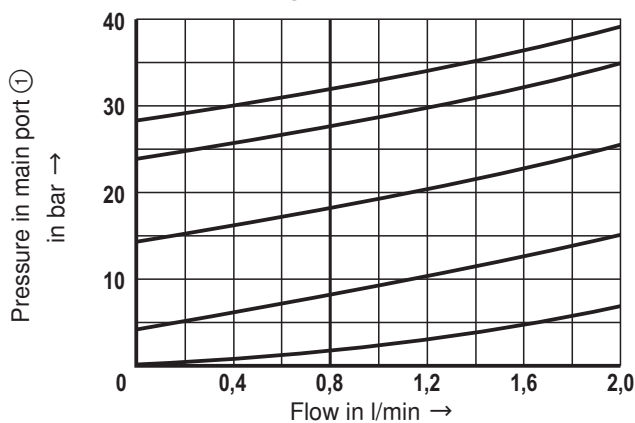

**Pressure rating 50 bar**

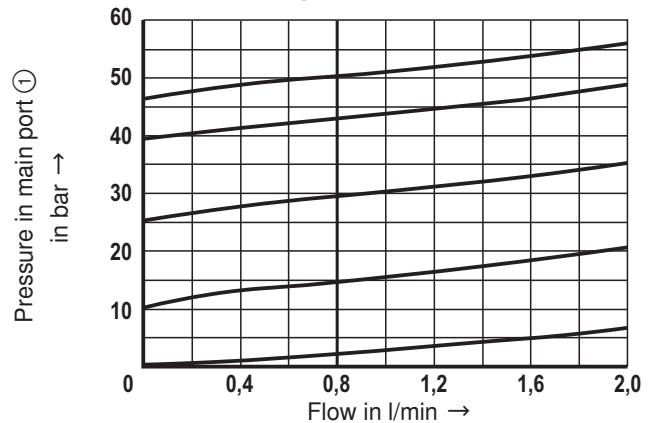

**Pressure rating 100 bar**

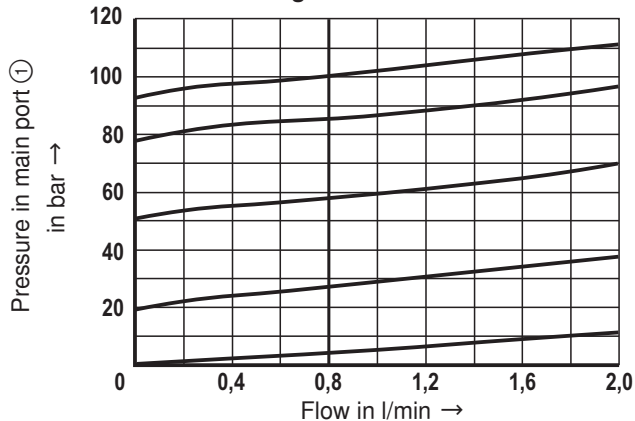

**Pressure rating 150 bar**

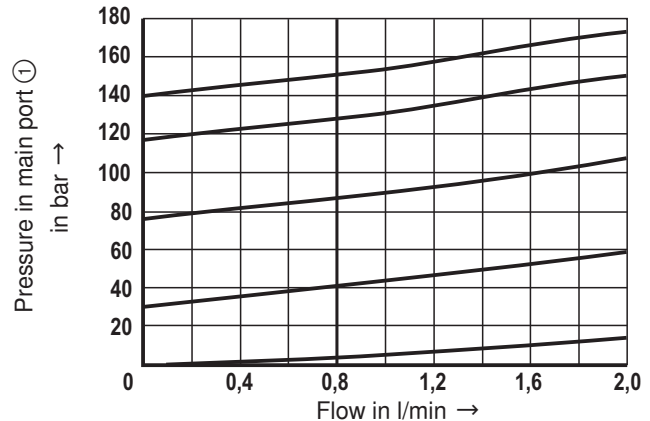

**Characteristic curves** (measured with HLP46,  $\vartheta_{oil} = 40 \text{ }^\circ\text{C} \pm 5 \text{ }^\circ\text{C}$  and 24 V coil)

**Pressure in main port ① depending on the flow.**

(The characteristic curve was measured without counter pressure in main port ②.)

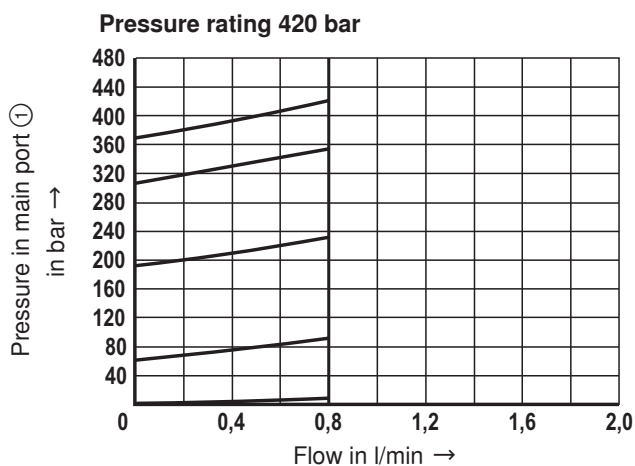
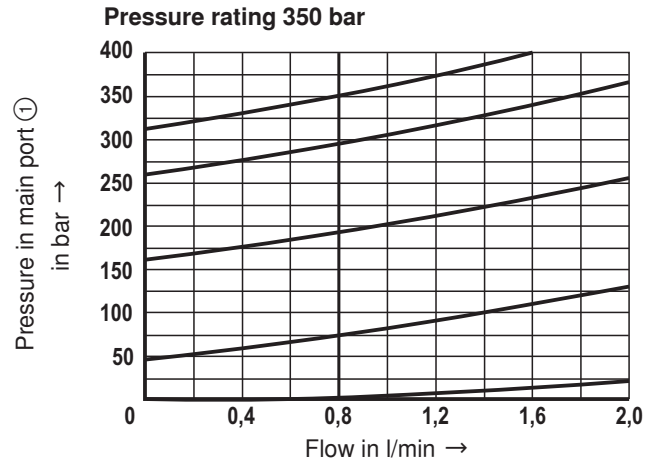
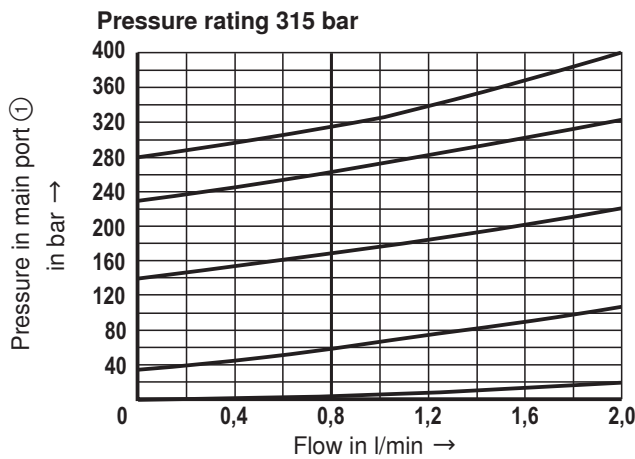
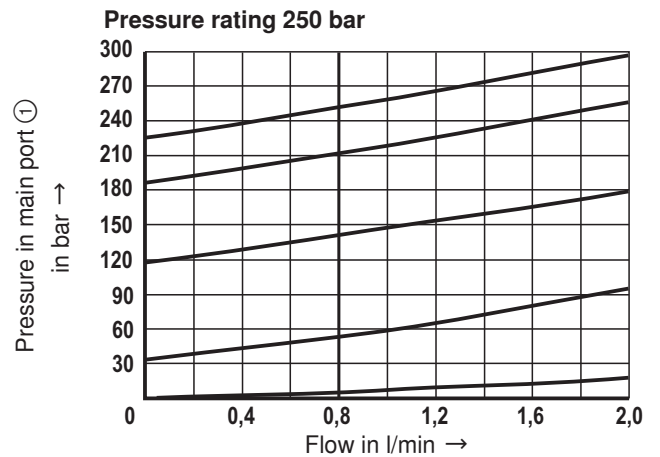
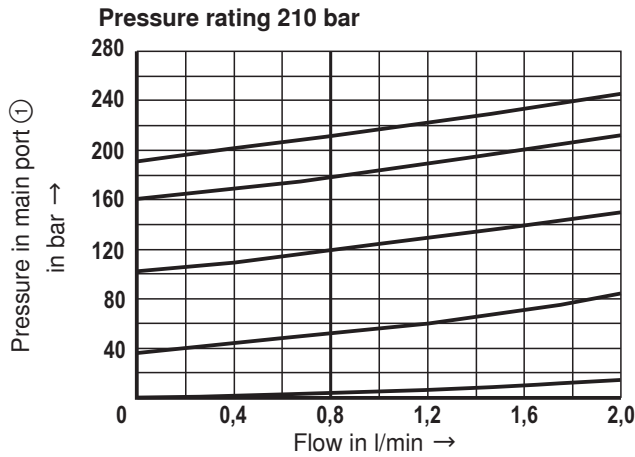

## Characteristic curves (measured with HLP46, $\vartheta_{\text{Oil}} = 40 \text{ }^\circ\text{C} \pm 5 \text{ }^\circ\text{C}$ and 24 V coil)

Minimum set pressure in main port ① with command value 100 %.

(The characteristic curve was measured without counter pressure in main port ②.)

Pressure rating 30 bar

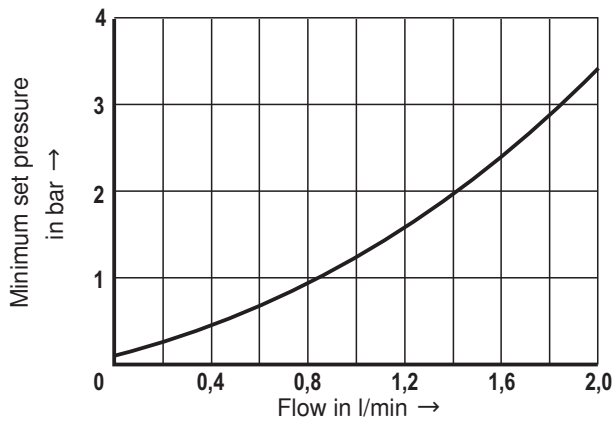

Pressure rating 50 bar

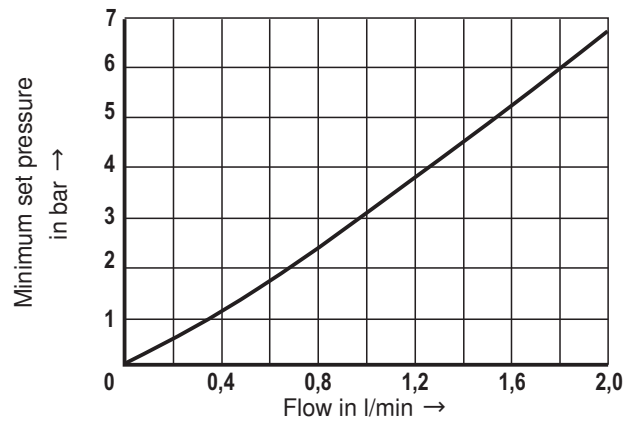

Pressure rating 100 bar

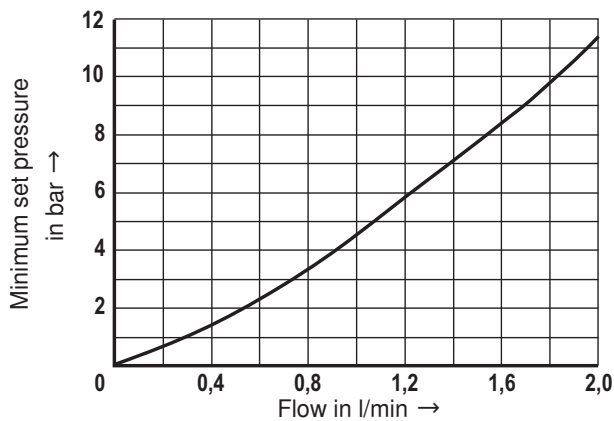

Pressure rating 150 bar

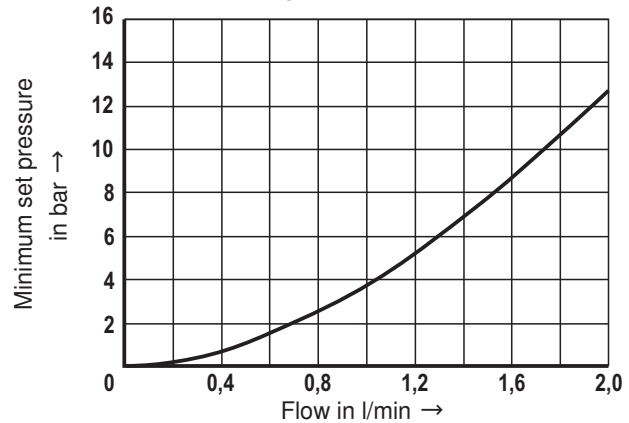

Pressure rating 210 bar

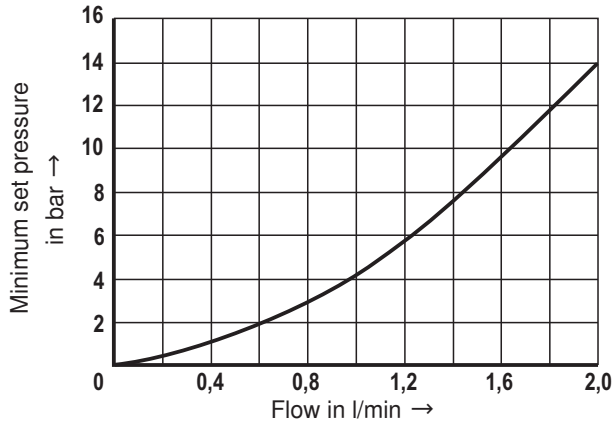

Pressure rating 250 bar

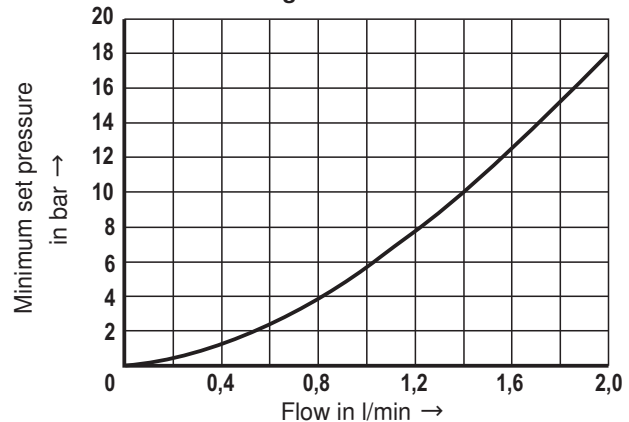



**Characteristic curves** (measured with HLP46,  $\vartheta_{oil} = 40 \text{ °C} \pm 5 \text{ °C}$  and 24 V coil)**Minimum set pressure in main port ① with command value 100 %.**

(The characteristic curve was measured without counter pressure in main port ②.)

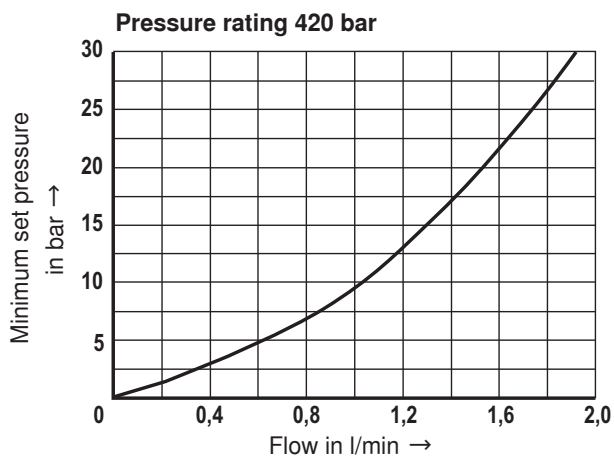
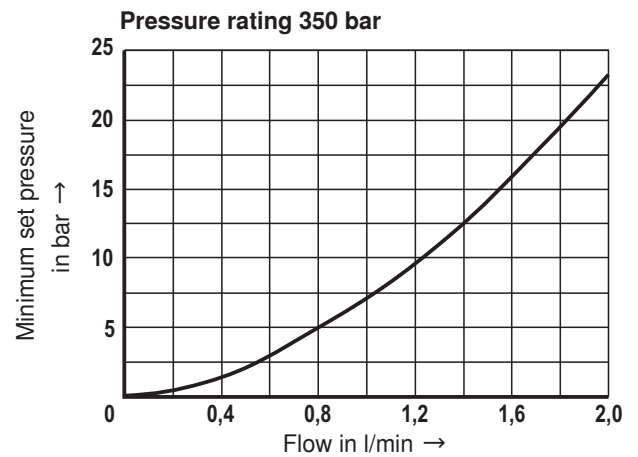
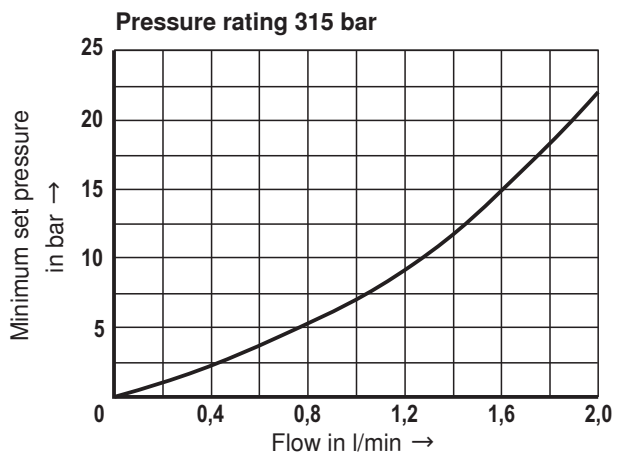

## Minimum terminal voltage at the coil and relative duty cycle

### Admissible working range against the ambient temperature

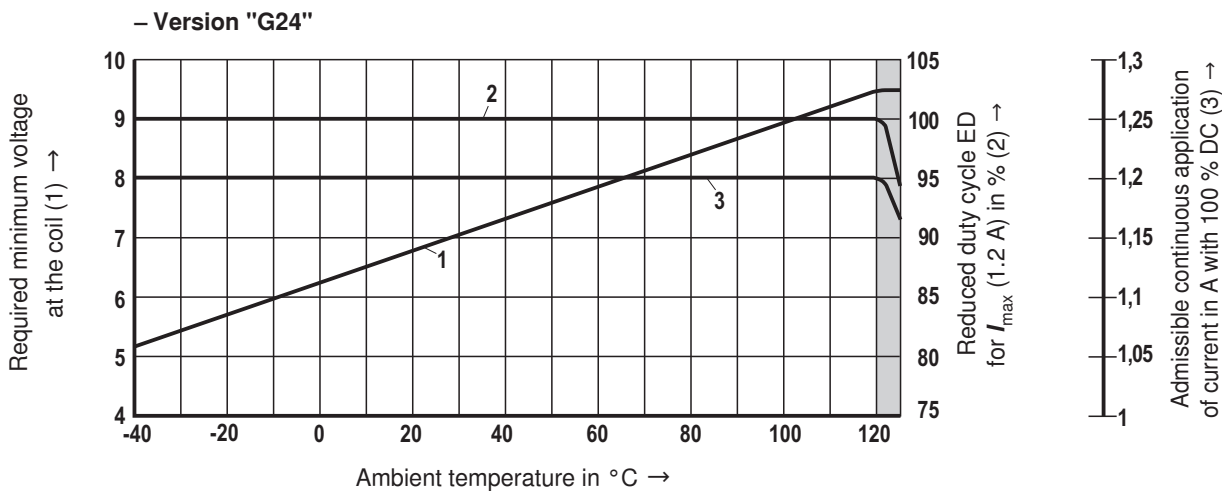
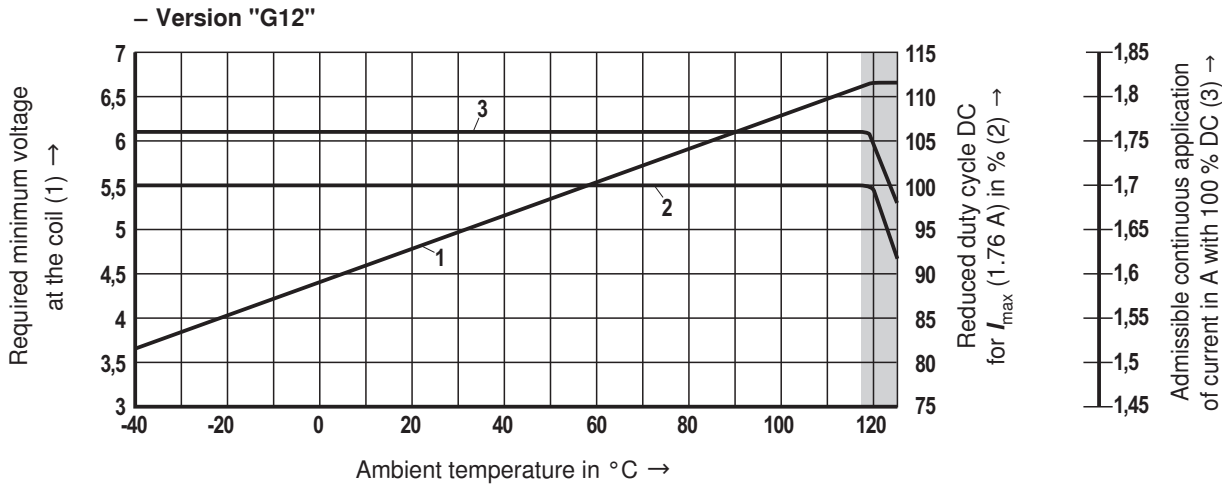

Limited valve performance

**Notice!**

The characteristic curves have been determined for coils with valve with medium test block size (80 x 80 x 80 mm), without flow in calm air.

Depending on the installation conditions (block size, flow, air circulation, etc.) there may be a better heat dissipation. Thus, the area of application is broadened.

In single cases, more unfavorable conditions may lead to limitations of the area of application.

## Minimum terminal voltage at the coil and relative duty cycle

### Admissible working range against the ambient temperature

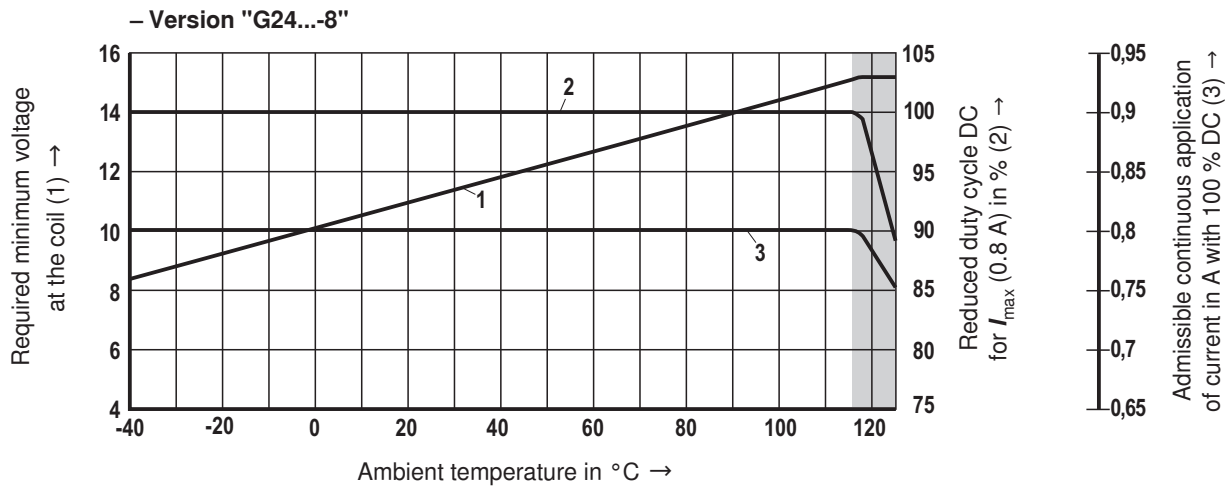

 Limited valve performance

#### Notice!

The characteristic curves have been determined for coils with valve with medium test block size (80 x 80 x 80 mm), without flow in calm air.

Depending on the installation conditions (block size, flow, air circulation, etc.) there may be a better heat dissipation. Thus, the area of application is broadened.

In single cases, more unfavorable conditions may lead to limitations of the area of application.

## Unit dimensions (dimensions in mm)

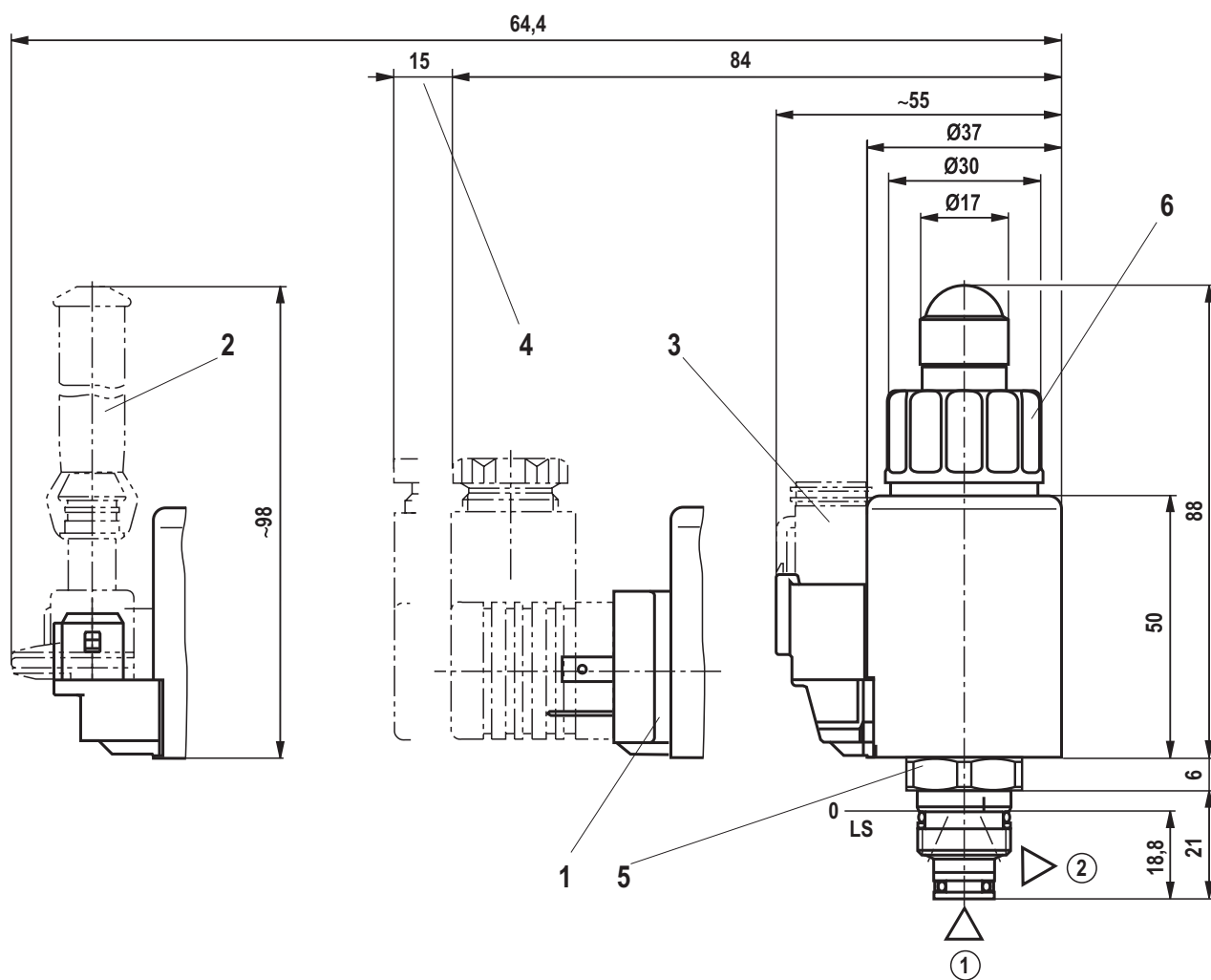

① = main port 1

② = main port 2

LS = Location Shoulder

- 1 Mating connector for connector "K4"  
(separate order, see data sheet 08006)
- 2 Mating connector for connector "C4"  
(separate order, see data sheet 08006)
- 3 Mating connector for connector "K40"  
(separate order, see data sheet 08006)
- 4 Space required to remove the mating connector
- 5 Hexagon SW22 for screwing in the  
pole tube; tightening torque  $M_A = 40^{+6}$  Nm
- 6 Solenoid nut, tightening torque  $M_A = 5^{+1}$  Nm

**Mounting cavity R/T-8A; 2 main ports; thread M16 x 1.5-6H (dimensions in mm)**

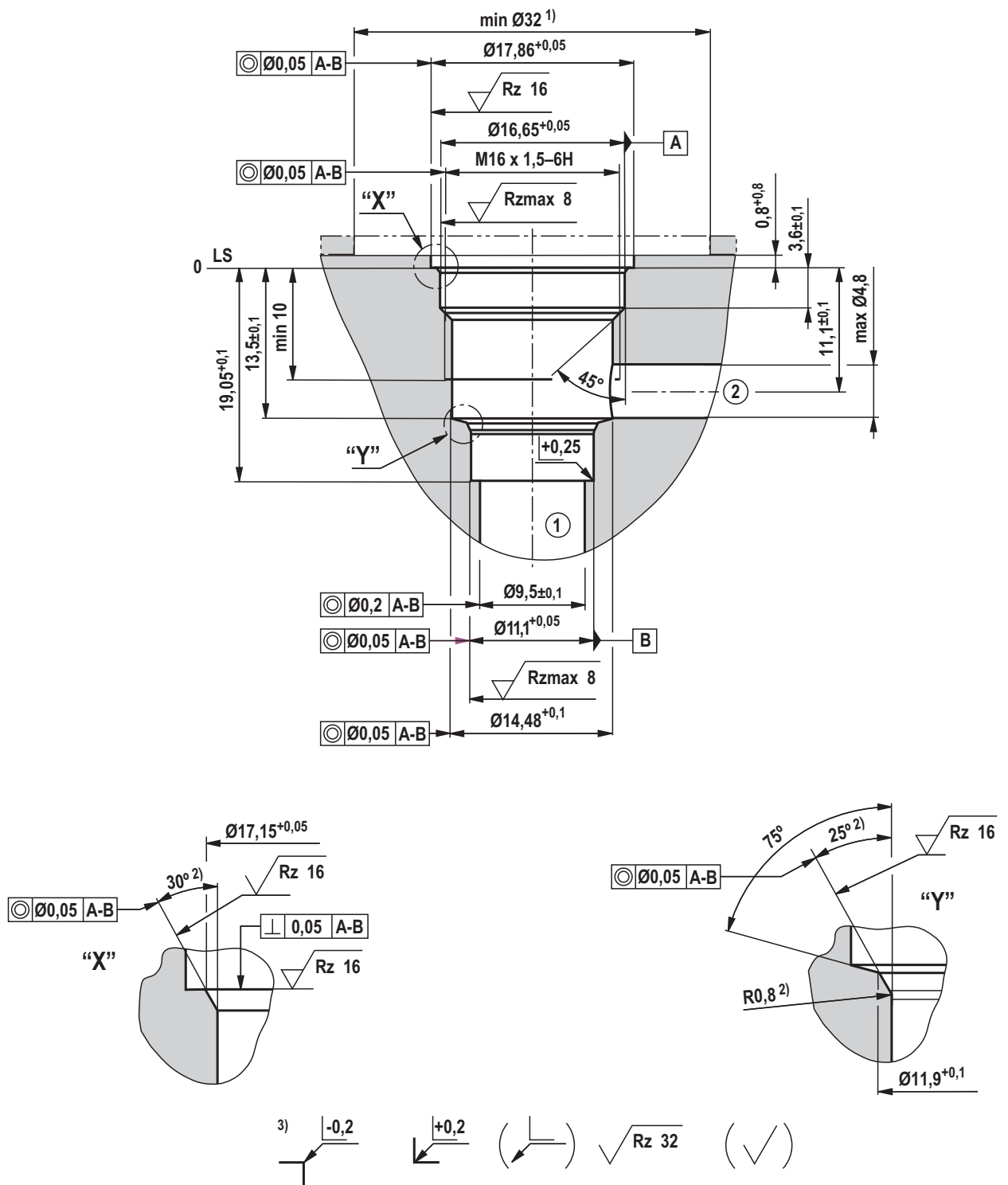

1) With counterbore, deviating from T-8A

2) All seal ring insertion faces are rounded and free of burrs

3) Deviating from T-8A

① = main port 1

② = main port 2

LS = Location Shoulder

Tolerance for all angles ±0.5°

## Available individual components

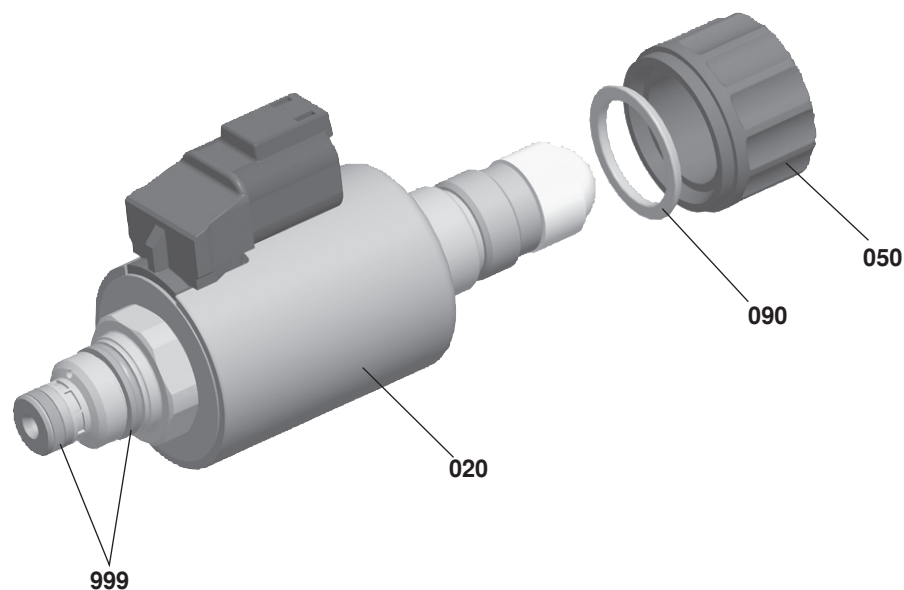

Item	Denomination		Direct voltage	Material no.
020	Coil for individual connection <sup>1)</sup>	Version "K4"	12 V	R901002932
			24 V	R901002319
			24 V / 800 mA	R901049962
	Version "K40"	12 V	R901003055	
		24 V	R901003053	
		24 V / 800 mA	R901050010	
	Version "C4"	12 V	R901003044	
		24 V	R901003026	
		24 V / 800 mA	R901049963	
050	Nut		R900992146	
090	Seal ring for pole tube		R900007769	
998	Seal kit of the valve		R961000376	

### Notice!

After exchange of the solenoid coil, the pressure set in the factory may change by  $\pm 5\%$ .

## Notes

---

Bosch Rexroth AG  
Hydraulics  
Zum Eisengießer 1  
97816 Lohr am Main, Germany  
Phone +49 (0) 93 52 / 18-0  
documentation@boschrexroth.de  
www.boschrexroth.de

© This document, as well as the data, specifications and other information set forth in it, are the exclusive property of Bosch Rexroth AG. It may not be reproduced or given to third parties without its consent. The data specified above only serve to describe the product. No statements concerning a certain condition or suitability for a certain application can be derived from our information. The information given does not release the user from the obligation of own judgment and verification. It must be remembered that our products are subject to a natural process of wear and aging.

## Notes

---